

it depends on the way in which LRPE is interpolated to small b . Since there is no unique way to make this interpolation, we must make an arbitrary choice. In our calculations we used the interpolation Eq. (22). Here we show how $f_{\Delta\lambda}^{\pi}$ can be used to approximate $f_{\Delta\lambda}^{\pi}$ [see Eq. (27)].

The functions $f_{\Delta\lambda}^{\pi}$ depend on the two elastic scattering parameters c and a . For meson-baryon scattering $c=0.58$ and $a=4.5$. We can effectively take into account the absorption appropriate to meson-baryon scattering contained in $f_{\Delta\lambda}^{\pi}$ by choosing $a_0=5.25$ (GeV/c)⁻¹ and $a_1=6.2$ (GeV/c)⁻¹ in $f_{\Delta\lambda}^{\pi}$. For $\Delta\lambda=0$ and $\mu'=\mu$, the equality $f_0^{\pi}=f_0'^{\pi}$ is valid to 5% for $-t\leq\mu^2$. For $\mu'=1.5\mu$, the equality $f_0^{\pi}=f_0'^{\pi}$ is valid to 10% for $-t'\leq\mu'^2$.

For $\Delta\lambda=1$ and $\mu'=\mu$, the equality $f_1^{\pi}=f_1'^{\pi}$ is valid to 10% for $-t\leq 2\mu^2$. For $\mu'=1.5\mu$, the equality $f_1^{\pi}=f_1'^{\pi}$ is valid to 15% for $-t'\leq 2\mu'^2$. For baryon-baryon scattering the absorption in $f_{\Delta\lambda}^{\pi}$ is larger. For this case, for $\Delta\lambda=0$ and $\Delta\lambda=1$ and $\mu'=\mu$, $f_{\Delta\lambda}^{\pi}=f_{\Delta\lambda}'^{\pi}$ within 15% for $-t\leq\mu^2$ when $a_0=6.25$ (GeV/c)⁻¹ and $a_1=6.75$ (GeV/c)⁻¹.

Note that Eq. (C3) gives the energy dependence of LRPE at $t'=0$ to be

$$f_0'^{\pi}(s, t'=0) = (-1)^{(\Delta\lambda-|\Delta\lambda|)/2} (a_0/\mu') K_1(a_0\mu'). \quad (C4)$$

For a_0 nonzero and energy independent, $f_0'^{\pi}(s, t'=0)$ decreases with energy more slowly than the Born approximation, which is given by the limit $a_0=0$.

Pion-Pion Scattering Information from $e^-e^+ \rightarrow \pi^-\pi^+\gamma$ †

M. J. CREUTZ* AND M. B. EINHORN

Stanford Linear Accelerator Center, Stanford University, Stanford, California 94305

(Received 29 December 1969)

We show how the reaction $e^-e^+ \rightarrow \pi^-\pi^+\gamma$ can be used to study the dipion system in states of even charge conjugation (and even angular momentum). In particular, its utility for experimentally investigating an $I=0, J=0$ resonance (ϵ meson) is discussed in detail.

INTRODUCTION

TO lowest order in the fine-structure constant α , the reaction $e^-+e^+ \rightarrow H$ (H being any neutral hadronic system) produces only final states with charge conjugation (C) odd and angular momentum (J) equal to unity. This property is one of the primary advantages of electron-positron colliding beam experiments; i.e., it allows the careful experimental study of a specific hadronic channel. Already this reaction has yielded beautiful results on the pion¹ and kaon² form factors as well as the three-pion final state.^{2,3} However, this property is at the same time one of the limitations of electron-positron storage rings, since one would also like to investigate experimentally other hadronic channels. In a previous paper,⁴ we showed how one could use reactions of the form

$$e^-+e^+ \rightarrow H+\gamma,$$

where γ is a hard photon, to study hadronic systems

with even C . Although the hadrons H may emerge from this reaction with either even or odd C , quantum electrodynamics plus knowledge of the cross section for $e^-+e^+ \rightarrow H$ allows one to remove the odd- C contribution. Consequently, the effects of the production of hadronic states with even C can be isolated and studied in a model-independent way. We have illustrated⁴ the method of analysis by considering the reaction

$$e^-+e^+ \rightarrow \pi^-\pi^+\gamma.$$

In this expanded discussion we will present the details of the analysis and consider further experimental problems and theoretical implications.

The outline of the paper is as follows: In Sec. I we summarize the theoretical predictions and experimental results bearing on the existence of an $I=0, J=0$ dipion resonance (the ϵ meson). In Sec. II we discuss the kinematics of the reaction being considered. We include here a brief discussion of how such an experiment may be analyzed and discuss some features of the Dalitz plot. In Sec. III a particular model for estimating the order of magnitude of the contribution from the ϵ meson is presented. In Sec. IV we discuss the constraints that unitarity imposes on the production amplitude. We point out in particular that there is no simple analog here of the Fermi-Watson final-state

† Work supported by the U.S. Atomic Energy Commission.

* NSF Graduate Fellow.

¹ J. E. Augustin *et al.*, Phys. Letters **28B**, 508 (1969); V. L. Auslander *et al.*, *ibid.* **25B**, 433 (1967).

² J. E. Augustin *et al.*, Phys. Letters **28B**, 517 (1969).

³ J. E. Augustin *et al.*, Phys. Letters **28B**, 513 (1969).

⁴ M. J. Creutz and M. B. Einhorn, Phys. Rev. Letters **24**, 341 (1970) (hereafter referred to as L).

interaction theorem.⁵ We also suggest a formalism which may be useful for parametrizing the data. The final section concludes with some general remarks on related problems and reactions.

I. ϵ MESON

Although pion-pion collisions may some day be experimentally possible,⁶ so far all such scattering information must be inferred indirectly. Consequently, statements on the experimental knowledge of $\pi\pi$ interactions are inextricably linked to theoretical models of various other reactions. The most popular reaction, for which experimental data are now abundant, has been $\pi N \rightarrow 2\pi N$.⁷ However, the theoretical foundations for extracting pion phase shifts are shaky and, not surprisingly, applying the same methods of analysis to different charge states for this reaction sometimes leads to ambiguous, if not contradictory, results.⁷ The results agree concerning the $I=2$, s -wave $\pi\pi$ phase shift δ_0^2 ; it is quite small and negative, decreasing from 0° at 300 MeV to about -20° at 1000 MeV. This confirms that there is no exotic resonance in this channel over this energy range. The $I=1$, p -wave phase δ_1^1 contains the ρ -meson resonance, as we know it must from measurements⁴ of the pion form factor in $e^-e^+ \rightarrow \pi^-\pi^+$. The $I=0$, s -wave phase δ_0^0 is the most controversial. At best, a broad resonance somewhere between 650 and 900 MeV is compatible with the data but not unambiguously implied by them.⁷ In our opinion, the strongest quantitative evidence for believing that the ϵ exists comes from two recent experiments⁸ on $\pi^-p \rightarrow \pi^0\pi^0n$. The $2\pi^0$ state cannot couple to an $I=1$ state, such as the ρ meson, and hence background problems are considerably less than when charged pions are produced in this process. The broad bump reported in the dipion invariant mass spectrum is probably due to the ϵ resonance, although the mass and width are quite model dependent and not well determined.

Theoretically, there are a number of reasons for believing in the existence of the ϵ meson. Although nearly all such predictions are based on current algebra, one of the earliest is not. Lovelace *et al.*⁹ investigated the contribution of $\pi\pi \rightarrow N\bar{N}$ to backward πN

scattering via dispersion relations. In the unphysical region from $2m_\pi$ to 800–1000 MeV, the phase of $\pi\pi \rightarrow N\bar{N}$ in the s wave is just δ_0^0 . Assuming no d -wave contribution, it was found that backward πN scattering is sensitive to this phase shift, and these authors found that they could only fit the πN data with a resonant phase. The fit was not very sensitive to the mass or width of the resonance, but that there be a resonance was an unavoidable conclusion.

Following Weinberg's calculation of the s -wave $\pi\pi$ scattering lengths,¹⁰ Carbone *et al.*¹¹ used dispersion relations to investigate the validity of the extrapolation of the current-algebra prediction of the scattering lengths for zero-mass pions to the physical threshold for massive pions. As expected, such an extrapolation is sensitive to a low-lying s -wave resonance. They found, for example, that for $m_\epsilon \gtrsim 700$ MeV, the correction due to the extrapolation was 20% or less. On the other hand, for m_ϵ less than 500 MeV, the correction grew to more than 100%. Thus if the theorems on soft pions are to hold and if Weinberg's prediction of pion scattering lengths is to be valid, there cannot be an ϵ with mass below 700 MeV. More ambitious calculations¹² showed that a broad ϵ with a mass between 700 and 1000 MeV provided consistent parametrizations of the data then available but such a resonance was not necessarily required.

Stronger theoretical motivation for this meson comes from the saturation by resonances of sum rules implied by current algebra.¹³ An ϵ meson is definitely required for consistency, and, in fact, these schemes suggest that $m_\epsilon = m_\rho$ and that the width Γ_ϵ is very large (~ 400 MeV). Finally, these features are reproduced in Veneziano's model applied to $\pi\pi$ scattering.¹⁴ The ϵ is the 0^+ daughter of the ρ , degenerate in mass with the ρ , having a width of about 400 MeV.

Should the ϵ meson be found not to exist in nature, a good deal of the theory built up from the current algebra would have to be modified somehow. Clearly, then, the experimental confirmation of the existence of the ϵ is interesting and important.

II. KINEMATICS

The qualitative features of the analysis of the reaction $e^-e^+ \rightarrow \pi^-\pi^+\gamma$ were discussed in L.⁴ For continuity, we summarize the discussion here. To order e^2 , the amplitude for the reaction is written as the sum of two

⁵ See, for example, S. Gasiorowicz, *Elementary Particle Physics* (Wiley, New York, 1966), p. 449.

⁶ P. L. Csonka, CERN Report No. 67-30 (unpublished); R. Macek and R. Maglic, University of Pennsylvania Report No. PPAR-14, 1969 (unpublished).

⁷ Excellent reviews on this subject were presented in Proceedings of the Argonne Conference on the $\pi\pi$ and $K\pi$ Interactions, Argonne National Laboratory, 1969 (unpublished)—hereafter referred to as the Argonne Conference. See in particular the summaries by L. J. Gutay and by P. E. Schlein. See also the experiment reported by K. J. Braun, D. Cline, and V. R. Sherer. A subsequent reference is G. A. Smith and R. J. Manning, *Phys. Rev. Letters* **23**, 335 (1969).

⁸ P. Sonderegger and P. Bonamy, reported in Proceedings of the Lund International Conference on Elementary Particles, 1969 (unpublished); W. Deinet *et al.*, *Phys. Letters* **30B**, 359 (1969). Since writing this, a third $2\pi^0$ experiment appeared: Z. S. Strugalski *et al.*, *ibid.* **29B**, 518 (1969).

⁹ C. Lovelace *et al.*, *Phys. Letters* **22**, 332 (1966).

¹⁰ S. Weinberg, *Phys. Rev. Letters* **17**, 616 (1966).

¹¹ G. Carbone *et al.*, *Nuovo Cimento* **58A**, 668 (1968).

¹² A sample of such references has been supplied by S. Weinberg, in *Proceedings of the Fourteenth International Conference on High-Energy Physics, Vienna, 1968*, edited by J. Prentki and J. Steinberger (CERN, Geneva, 1968), p. 263. In view of the recent experiments (Ref. 8), perhaps some theoretical reanalysis would be useful. Unlike the previous analyses, this would probably show that a broad ϵ is not only consistent with the data but also is necessary in order to fit the data.

¹³ F. J. Gilman and H. Harari, *Phys. Rev.* **165**, 1803 (1968). S. Weinberg, *Phys. Rev. Letters* **22**, 1023 (1969).

¹⁴ A summary of applications of the model to $\pi\pi$ scattering was presented by C. Lovelace, the Argonne Conference.

terms which are distinguished by the charge conjugation value (C) of the dipion system (see Fig. 1). In A , the pions have C even and, hence, by Bose statistics, have their relative angular momentum J even. In B , the pions have C odd and, because they interact with the electromagnetic current, must have $J=1$. It follows from the generalized Pauli principal that in A (B) the pions have $I=0$ or 2 ($I=1$). The differential cross section $d\sigma_{-+}$ for $e^-e^+\rightarrow\pi^-\pi^+\gamma$ is proportional to $|A+B|^2$. Under the exchange of the pion charges (or momenta) the amplitude B changes sign but A does not. Thus the cross section for producing charged pions is $d\sigma_{\text{ch}}=d\sigma_{-+}+d\sigma_{+-}\propto|A|^2+|B|^2$. Knowing the magnitude of the pion form factor¹⁵ from $e^-e^+\rightarrow\pi^-\pi^+$ and using quantum electrodynamics, one can calculate the magnitude of $|B|$ precisely. Consequently $|B|^2$ may be removed from $d\sigma_{\text{ch}}$ in a model-independent way. Thus, $|A|^2$, the contribution to $d\sigma_{\text{ch}}$ from dipion states with even charge conjugation (and even angular momenta), may be unambiguously isolated. If there is a dipion resonance with even angular momentum, it should appear as a resonance peak in $|A|^2$.

If an experiment is done in which the charge of each pion is identified so that $d\sigma_{-+}$ and $d\sigma_{+-}$ are separately known, then the interference term may be easily isolated from the difference:

$$d\sigma_{-+}-d\sigma_{+-}\propto\text{Re}(A^*B).$$

Combined with the previous determination of $|A|$, the interference term yields the relative phase between A and B .

We now enter into the detailed expression of the ideas sketched above. Define the electron and positron momenta¹⁶ to be L_- and l_+ , respectively; the π^- , π^+ momenta, q_- , q_+ ; the photon momentum, k . We define the following useful sum and difference momenta:

$$\begin{aligned} P &= l_- + l_+, & L &= l_- - l_+, \\ Q &= q_- + q_+, & \Delta &= q_- - q_+. \end{aligned} \quad (1)$$

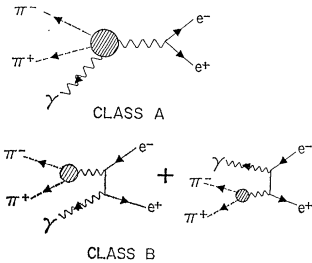
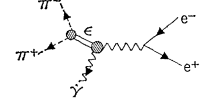

FIG. 1. Classification of diagrams.

¹⁵ As we point out later, the magnitude of the pion form factor can be determined from an analysis of $e^-e^+\rightarrow\pi^-\pi^+\gamma$ itself. Hence the assumption of knowledge of the form factor is practically convenient but theoretically unnecessary.

¹⁶ For the energies under consideration here, it is an excellent approximation (better than one part in 10^6) to neglect the electron mass. Recall that $\bar{u}u=\bar{v}v=0$ for massless electrons.

FIG. 2. Contribution of the ϵ .



Momentum conservation is expressed by $P=Q+k$. Finally, define scalar invariants

$$s=P^2, \quad t=Q^2, \quad (2)$$

$$(Q\Delta PL)=\epsilon_{\mu\nu\rho\sigma}Q^\mu\Delta^\nu P^\rho L^\sigma.$$

In addition, we define three angles in terms of the manifestly covariant quantities¹³

$$\begin{aligned} u &= k \cdot \Delta = -\frac{1}{2}(s-t)\beta_\pi \cos\theta_{\pi\gamma}, \\ v &= k \cdot L = -\frac{1}{2}(s-t)\cos\theta_\gamma, \end{aligned} \quad (3)$$

$$(Q\Delta PL) = -(st)^{1/2} \frac{1}{2}(s-t)\beta_\pi \sin\theta_\gamma \sin\theta_{\pi\gamma} \sin\phi.$$

Here, β_π is the velocity of the pions in the dipion center-of-mass system. We also denote $w=L\cdot\Delta$. These angles have simple physical interpretations: $\theta_{\pi\gamma}$ is the angle between the photon and one of the pions in the dipion rest frame; θ_γ is the angle between photon and the direction of the electron axis in the electron-positron center-of-mass system; in either of the two Lorentz frames, ϕ is the angle between the electron-positron-photon plane and the pion-pion-photon plane. The amplitudes corresponding to A and B are

$$A = (e^1/s)\bar{v}(l_+)\gamma_\mu u(l_-)_{\text{out}}\langle\pi^-\pi^+\gamma|j^\mu|0\rangle, \quad (4a)$$

$$\begin{aligned} B &= (ie^2/t)\bar{v}(l_+)\left[\gamma\cdot\epsilon^*(\mathbf{k}-\mathbf{l}_+)^{-1}\gamma_\mu+\gamma_\mu(\mathbf{L}-\mathbf{k})^{-1}\gamma\cdot\epsilon^*\right] \\ &\quad \times u(l_-)_{\text{out}}\langle\pi^-\pi^+\gamma|j^\mu|0\rangle. \end{aligned} \quad (4b)$$

Here ϵ_ν is the photon polarization vector; u (\bar{v}) is the electron (positron) spinor, j^μ the electromagnetic current.¹⁷ Recall that the vertex in B is related to the pion form factor according to

$$\text{out}\langle\pi^-\pi^+\gamma|j^\mu|0\rangle = -e\Delta^\nu F_\pi(t). \quad (5)$$

Turning to A , we define a tensor $H^{\nu\mu}$ by

$$\langle\pi^-\pi^+\gamma|j^\mu|0\rangle = ie^2\epsilon_\nu^* H^{\nu\mu}. \quad (6)$$

The most general form for the “virtual γ ” $\rightarrow\pi^-\pi^+\gamma$ vertex, consistent with gauge invariance and current conservation, may be taken to be

$$\begin{aligned} H^{\nu\mu} &= [P^\nu(k\cdot\Delta/k\cdot P) - \Delta^\nu]\{H_1(P^\mu - sk^\mu/k\cdot P) \\ &\quad + H_2[\Delta^\mu - (k\cdot\Delta/k\cdot P)k^\mu]\} + H_3[g^{\nu\mu} - P^\nu k^\mu/k\cdot P]. \end{aligned} \quad (7)$$

The form factors¹⁸ H_i depend on three kinematical invariants, which we choose to be $(s, t, \cos\theta_{\pi\gamma})$. In the decomposition (7), the contribution from a scalar dipion resonance (Fig. 2) enters only into H_3 , and,

¹⁷ Our normalization of spinors is the one appropriate to massless fermions, viz., $u^\dagger u = 2E$.

¹⁸ Although convenient algebraically, this decomposition of the tensor into invariant functions may not be the most convenient for analytical purposes. In particular, we expect the H_i to have kinematical singularities.

to the extent the scalar partial wave dominates, H_3 will be independent of $\theta_{\pi\gamma}$, i.e., in its rest frame, a scalar resonance decays isotropically into two pions. An experimental test of this is a good check on the spin of the resonance.

The differential cross section $d^5\sigma_{-+}$ for the reaction $e^-e^+\rightarrow\pi^-\pi^+\gamma$ is

$$d^5\sigma_{-+} = |A+B|^2 d^5\Phi,$$

where $d^5\Phi$ is the invariant phase space. The unpolarized cross section $\langle d^5\sigma_{-+} \rangle$ involves averaging $|A+B|^2$ over the lepton spins and summing over the photon polarizations. This average rate $\langle |A+B|^2 \rangle$ is independent under rotations about the beam axis (in the electron-positron rest frame). We eliminate the redundant variable by integrating this angle from 0 to 2π to get

$$\langle d^4\sigma_{-+} \rangle = \langle |A+B|^2 \rangle d^4\Phi.$$

The phase space may be simply expressed as

$$d^4\Phi/dtdudv dw = [1/4(4\pi)^4 s^2] [1/|PLQ\Delta|], \quad (8)$$

where the covariant variables s , t , u , v , and w were introduced earlier [Eqs. (2) and (3)]. From this covariant expression (8), it is straightforward to express the phase space in any convenient Lorentz frame.

The cross section for charged pions is

$$d^5\sigma_{\text{ch}} = d^5\sigma_{-+} + d^5\sigma_{+-} = (|A|^2 + |B|^2) d^5\Phi.$$

The contribution from $|B|^2$, averaged over lepton spins, may be written as

$$\langle |B|^2 \rangle = [2e^6 |F_\pi(t)|^2/t(s-t)^2 \sin^2\theta_\gamma] [4(\beta_\pi^2 st - w^2) + \beta_\pi^2 (s-t)^2 (\sin^2\theta_{\pi\gamma} + \cos^2\theta_\gamma)]. \quad (9)$$

If we denote by β the relative velocity between the dipion and dilepton rest frames, then w may be expressed as

$$w = -\beta_\pi (st)^{1/2} (\gamma \cos\theta_{\pi\gamma} \cos\theta_\gamma + \sin\theta_{\pi\gamma} \sin\theta_\gamma \cos\phi),$$

where $\gamma = 1/(1-\beta^2)^{1/2}$. The contribution from $|A|^2$ is very complicated algebraically and is reproduced in an appendix for those interested in such unpleasant details. It is interesting that, from the unpolarized differential cross section $\langle d^4\sigma_{-+} \rangle$, all four form factors, F_π , H_1 , H_2 , and H_3 , can be extracted both as to magnitudes and relative phases. In this respect, this process bears a strong resemblance to $K_{\ell 4}$ decay.¹⁹ As is discussed further below, a scalar resonance contributes only to H_3 and, barring certain sensitive directions in phase space, we expect H_3 to dominate H_1 and H_2 near the resonance. Here, then, we quote the contribution coming from H_3 :

$$\langle |A|^2 \rangle = [e^6 |H_3(s, t, \cos\theta_{\pi\gamma})|^2 / 2s] (1 + \cos^2\theta_\gamma).$$

The interference term is

$$d^5\sigma_{\text{int}} = d^5\sigma_{-+} - d^5\sigma_{+-} = 4 \text{Re}(A^*B) d^5\Phi.$$

¹⁹ A. Pais and S. B. Treiman, Phys. Rev. **168**, 1858 (1968).

Again, keeping only the contribution to A from H_3 , we find the contribution to the unpolarized difference:

$$\begin{aligned} \langle \text{Re}(A^*B) \rangle = & [e^6 \text{Re}(H_3 F_\pi^*) / 4st \sin^2\theta_\gamma] \\ & \times \{ [2s(s+t) - (s-t)^2 \sin^2\theta_\gamma] \beta_\pi \cos\theta_{\pi\gamma} \cos\theta_\gamma \\ & + 2w(s-t + (s+t) \cos^2\theta) \}. \end{aligned}$$

In the dilepton rest frame, the energy of the photon is $k^0 = (s-t)/2\sqrt{s}$. We note that the contribution from $|B|^2$ [Eq. (9)] shows the typical $1/k_0^2$ bremsstrahlung dependence. Similarly, from photon emission from external pion legs, there will be contributions to $|A|^2$ of this form. On the other hand, we expect the contribution from the ϵ resonance to be typical of internal bremsstrahlung, of order k_0^2 . Thus, it is necessary to observe a fairly hard photon to see the effect of the resonance. One can minimize the effect of the $1/k_0^2$ dependence by concentrating on those portions of phase space where such contributions are suppressed and, consequently, contributions from internal bremsstrahlung relative enhanced. For example, in $\langle |B|^2 \rangle$, if we choose $\beta_\pi^2 st - w^2 = 0$, then the numerator will be of order k_0^2 and cancel the $1/k_0^2$ in front.²⁰ One simple way to satisfy this condition experimentally (and in a manner which is independent of s and t) is to choose

$$\theta_\gamma = \frac{1}{2}\pi, \quad \theta_{\pi\gamma} = \frac{1}{2}\pi, \quad \phi = 0.$$

In the electron-positron rest frame, this corresponds to all particles lying in the same plane with the photon emitted at right angles to the beam direction. The pions are emitted symmetrically about the axis defined by the photon (Fig. 3). The arrangement also minimizes the contribution of external bremsstrahlung from pions. Even in an experiment with limited statistics, one could set up his photon detector on one side of the beam and his spark chamber for the pions on the other side.

It is easy to see that both the emitted photon and virtual photon in diagram A must have the same G parity; that is, they are either both isovector or both isoscalar photons. However, in B , the virtual photon couples to two pions and so must be an isovector. Thus, unlike A , B receives contributions from only isovector photons. We pointed out earlier⁴ that, for this reason, it is possible to enhance the contribution of A with respect to B by setting the colliding beam energy to an isoscalar resonance. The ϕ meson is par-

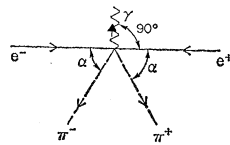

FIG. 3. Experimental configuration minimizing $|B|^2$.

²⁰ The existence of such a choice may be traced to the fact that, for a massless electron, $e^-e^+\rightarrow\pi^-\pi^+$ vanishes in the forward direction. This is due to the fact that the vector current coupling the leptons requires the massless electron and positron to have opposite helicities.

ticularly well suited for this purpose. The ϕ has a mass of 1019 MeV; hence, in the decay $\phi \rightarrow \epsilon \gamma$, the photon will carry off 200–300 MeV, depending on the mass of the ϵ .

One can think of other diagrams, corresponding to radiative decay of the ρ meson (Fig. 4), which might compete with the contribution from ϵ (Fig. 3). However, if one constructs a Dalitz plot (Fig. 5) for the final-state kinematics, one sees that for $s = m_\phi^2$, there is rather little overlap between these contributions. In any case, their distinct signatures on such a plot should make them easy to separate. There is another reason why Fig. 4 is small, viz., the $\phi \rightarrow 3\pi$ coupling constant is known²¹ to be much smaller than might have been expected. Using the $\phi \rightarrow 3\pi$ rate to give an upper bound for $g_{\phi\rho\pi}$, the ϕ - ρ - π coupling constant, one can show Fig. 5 to give a smaller contribution by a factor of 10^{-1} – 10^{-2} than the contribution of the ϵ estimated in Sec. III.

III. MODEL FOR ϵ PRODUCTION

Having presented above a qualitative discussion of how best to observe the ϵ , we would like to compare this contribution to A with the contribution from B . It would be unfortunate if $|B|^2$ were very much larger than $|A|^2$, for the requirements on experimental errors would become extremely important. To obtain an estimate for the contribution of the ϵ , we used a model based on the idea of vector-meson dominance which we believe will yield the correct *order of magnitude* even though the model may be incorrect in its details. According to this model, depicted in Fig. 6, the contribution to H_3 is

$$H_3 = \left(\frac{g_{\epsilon\pi\pi}}{\sqrt{3}} \right) \frac{1}{t - (m_\epsilon - \frac{1}{2}i\Gamma_\epsilon)^2} \left(\frac{g_{\epsilon\phi\phi}}{m_\epsilon^2} \right) \left(\frac{m_\phi^2/g_\phi}{s - (m_\phi - \frac{1}{2}i\Gamma_\phi)^2} \right) \frac{1}{g_\phi} \times \frac{1}{2}(s-t).$$

$$\approx \frac{e^6 m_\rho^4}{(m_\rho^2 - m_\epsilon^2)^2 + (m_\rho \Gamma_\rho)^2} \left(\frac{2}{m_\epsilon^2} \right).$$

Recognizing the photon emitted as purely internal bremsstrahlung, the factor $k \cdot P = \frac{1}{2}(s-t)$ must be inserted in order to ensure the proper behavior of $H^{\nu\mu}$ for a soft photon [see Eq. (7)]. For dimensional reasons, the ϵ - ϕ - ϕ coupling constant has been written as $g_{\epsilon\phi\phi}/m_\epsilon^2$. The ϵ - π $^-$ - π $^+$ coupling has the Clebsch-Gordan coefficient $1/\sqrt{3}$ removed; the relation between $g_{\epsilon\pi\pi}$ and the width of the ϵ (assuming no inelasticity) is

$$m_\epsilon \Gamma_\epsilon = (g_{\epsilon\pi\pi}^2/32\pi) (1 - 4m_\pi^2/m_\epsilon^2)^{1/2}.$$

We maximize this contribution by choosing $s = m_\phi^2$, as discussed above, and $t = m_\epsilon^2$. The coupling constant

FIG. 4. Contribution of radiative ρ decay.

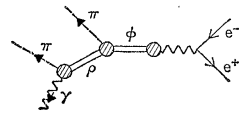

²¹ Particle Data Group, Rev. Mod. Phys. **41**, 109 (1969).

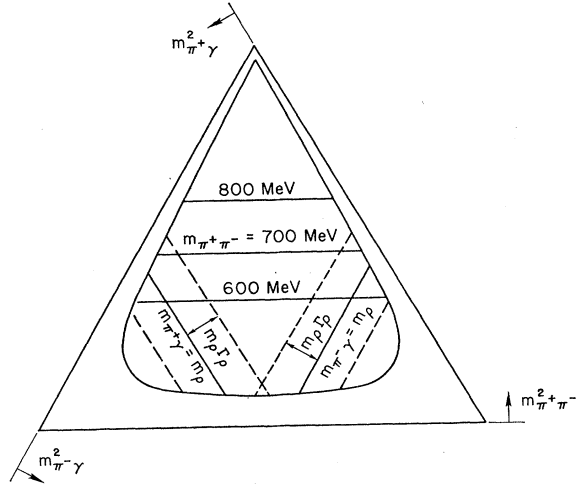

FIG. 5. Dalitz plot for the $\pi^+\pi^-\gamma$ final state at $s = m_\phi^2$.

$g_{\epsilon\phi\phi}$ is unknown. To get an order of magnitude, we assume this is of the same order as the strong coupling $g_{\epsilon\pi\pi}$, and thus we set²² $g_{\epsilon\phi\phi} = g_{\epsilon\pi\pi} = g_\epsilon$. With these assumptions, then, the contribution to $|A|^2$ for $\theta_\gamma = \frac{1}{2}\pi$, $\theta_{\pi\gamma} = \frac{1}{2}\pi$, $\phi = 0$ is

$$|A|^2 = \frac{1}{3}e^6 \left(\frac{m_\phi}{\Gamma_\phi} \right)^2 \frac{8}{(g_\phi^2/4\pi)^2} \left(\frac{m_\phi^2 - m_\epsilon^2}{m_\epsilon^2} \right)^2 \frac{1}{m_\epsilon^2}.$$

This is to be compared with the contribution of the ρ to $|B|^2$:

$$|B|^2 = \frac{2e^6}{m_\epsilon^2} |F_\pi(m_\epsilon^2)|^2 \beta_\pi^2$$

$$\approx \frac{e^6 m_\rho^4}{(m_\rho^2 - m_\epsilon^2)^2 + (m_\rho \Gamma_\rho)^2} \left(\frac{2}{m_\epsilon^2} \right).$$

If the ρ and ϵ are really degenerate, $m_\rho = m_\epsilon$, then

$$|B|^2 = (2e^6/m_\epsilon^2) (m_\rho/\Gamma_\rho)^2.$$

Comparing these expressions, we see the enormous enhancement of $|A|^2$ due to the narrowness of the ϕ peak compared to the ρ , viz.,

$$m_\phi/\Gamma_\phi \sim 250 \quad m_\rho/\Gamma_\rho \sim 5.$$

Using²³ $g_\phi^2/4\pi \approx 11$, we find that $|A|^2$ is nearly an order of magnitude larger than $|B|^2$. Even after inte-

²² Even if the ϵ is the daughter of the ρ , we know of no hereditary principle which suggests that the universality possessed by the ρ should be transmitted to the ϵ . We suspect, however, that such a characteristic might be inherent in the crossing-symmetric models first discussed by Veneziano. For example, see Ref. 14. Dr. S. Nussinov (private communication) has pointed out that, if the ϵ should turn out to be a mixture of purely non-strange quarks, then it will not couple to the ϕ meson, which, ideally, is purely $\lambda\lambda$. Thus $g_{\epsilon\phi\phi}$ will be suppressed for the same reason that $\phi \rightarrow 3\pi$ is suppressed. Although these quark-model arguments are never precisely borne out experimentally, it would be expected that our estimate in this section would be too optimistic for the relative magnitudes of A and B . However, the $SU(3)$ or quark assignment of the ϵ is unresolved at present.

²³ J. E. Augustin *et al.*, Phys. Letters **28B**, 503 (1969).

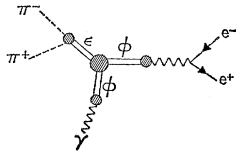

FIG. 6. Vector-meson-dominance model for the amplitude.

grating over a range of phase space

$$\frac{1}{3}\pi < \Theta_\gamma < \frac{2}{3}\pi, \quad \frac{1}{3}\pi < \Theta_{\pi\gamma} < \frac{2}{3}\pi, \quad 0 < \phi < 2\pi, \\ 0.1 \text{ GeV}^2 < t < 0.9 \text{ GeV}^2,$$

we find the contribution of a broad ϵ to dominate the contribution from the ρ . The cross section so obtained is on the order expected, $\sigma \sim 10^{-3} - 10^{-2} \mu\text{b}$.

In Fig. 7, we plot the contributions to $d\sigma/dt$ (over the region of phase space described in the preceding paragraph) for $|B|^2$ and for $|A|^2$ in the model above. Notice how badly skewed the ϵ -resonance contribution becomes for widths larger than 150 MeV. This asymmetry is attributable to two factors: (1) phase space which enhances the significance of small t values; and (2) the photon energy which multiplies the form factor H_3 gives a contribution $(s-t)^2$ to the cross section. This factor is characteristic of internal bremsstrahlung and, consequently, is independent of the particular model for the resonance. This suggests that one divide the experimentally determined value of $d\sigma/dt$ not by phase space alone (as is usually done), but by the contribution to $d\sigma/dt$ corresponding to a constant value of $H_3/(s-t)$. In the model above, this procedure isolates the Breit-Wigner approximation to H_3 , which may be a good first approximation to the data. The identification of the mass and width of a broad resonance from experimental data is a difficult problem in itself. It is clear from Fig. 7, however, that for $\Gamma_\epsilon > 150$ MeV, it would be a serious mistake to fit a Breit-Wigner formula to the experimental data for $d\sigma/dt$. In Sec. IV we suggest an alternative parametrization of H_3 .

So far as the actual experiment goes, we have emphasized above that one obtains very useful information without observing which pion has which charge. One knows the initial energy accurately. Presumably, one can use spark chambers to determine the directions in which the pions emerge and, somewhat less accurately, one can also determine the direction of the emerging photon in a shower counter. By observing the rate of buildup of the shower, one can estimate roughly the energy of the photon as well. These measurements, three directions and two energies, overdetermine the kinematics for the reaction $e^-e^+ \rightarrow \pi^-\pi^+\gamma$. In fact, there are two constraints available. Given the three directions, one can check that, in the electron-positron center-of-mass system, the three emerging particles are coplanar. Also, from the directions and a knowledge of the initial energy, one can calculate the photon's energy and compare with the measured value. These two constraints on the kinematics will be useful in discriminating against the reaction $e^-e^+ \rightarrow \mu^-\mu^+\gamma$ and against photon

background from $e^-e^+ \rightarrow \pi^-\pi^+\pi^0$, $\pi^0 \rightarrow 2\gamma$. Of course, if the magnitude of the pions' momenta are also measured, the reaction is even further overdetermined.

To conclude, we note that, given a storage ring with the luminosity of Adone (Frascati) or with the higher luminosity anticipated for CEA (Cambridge), the experiment discussed here is possible but the analysis of fully differential cross sections may be limited by poor statistics. With the luminosities projected for the storage rings at DESY (Hamburg) or SPEAR (SLAC), very detailed measurements will be possible and one will be able to determine the magnitude and relative phases of all four unknown amplitudes F_π , H_1 , H_2 , and H_3 . The analysis of H_3 should lead to reliable values for the ϵ mass and width. But, even with limited statistics, the ϵ will not be difficult to resolve.

IV. PHASE RELATIONS

In K_{l4} decay, as discussed by Pais and Trieman,¹⁹ one can derive a final-state interaction theorem. This theorem relates the phase of the K_{l4} decay amplitude to the pion-pion scattering phase shifts. The theorem is valid to lowest order in the weak and electromagnetic interactions, assuming time-reversal invariance and elastic unitarity. In the reaction

$$\gamma(s) \rightarrow \pi^+ + \pi^- + \gamma$$

[here $\gamma(s)$ represents the virtual photon of mass $= \sqrt{s}$], the final state again has two pions as the only hadrons. Thus one might naively expect a similar phase theorem to hold to the lowest order in the electromagnetic interaction. However, the amplitude for this process is at least second order in e , the electric charge. This fact, as we show below, destroys any exact phase theorem.

Physically the problem arises because the virtual photon can first decay into two pions which later interact to produce the final state. To the lowest non-trivial order in e , an isoscalar photon cannot decay into two pions. This enables one to derive a rigorous phase theorem which applied to isoscalar photons for $s \leq (3m_\pi)^2$.

We conclude this section with an approximate phase relation when s is near a vector-meson resonance. This relation becomes exact as the width of the vector meson goes to zero and s approaches the pole at the vector-meson mass squared.

To discuss the phase relations, it is easiest to use the basis of two-pion states described by²⁴ P =total four-momentum of the two-pion system, I =isospin, I_3 =third component of isospin, J =total angular momentum, and λ =component of angular momentum along \mathbf{P}

²⁴ To give precise meaning to a phase theorem, some arbitrary phase conventions must first be established. For example, the state with $\mathbf{P}=0$ can be chosen to be those defined by M. Jacob and G. C. Wick, Ann. Phys. (N.Y.) 7, 404 (1959). States with arbitrary (P^0, \mathbf{P}) may be defined from the state of the same P^2 , but $\mathbf{P}=0$ by boosting in the z direction and then rotating into the direction of \mathbf{P} .

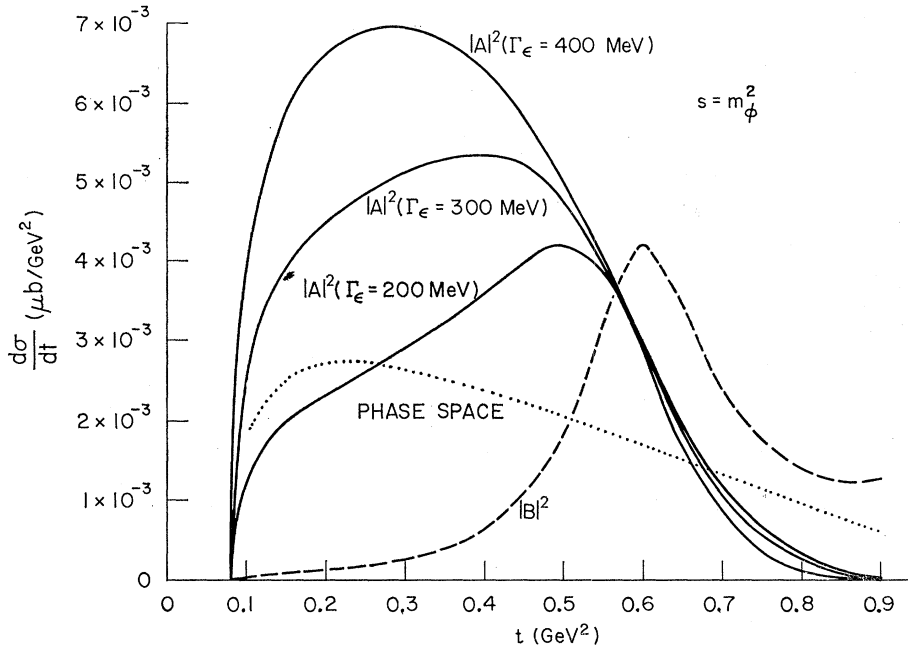
FIG. 7. Model cross sections for various Γ_ϵ .

(for states with $\mathbf{P}=0$ let $\lambda=J_3$). We normalize these states so that

$$\langle I', I_3', J', \lambda', P' | I, I_3, J, \lambda, P \rangle = \delta_{I'I} \delta_{J'J} \delta_{I_3'I_3} \delta_{\lambda'\lambda} (2\pi)^4 \delta^4(P' - P).$$

These states can be defined either in terms of two incoming pions at time equal to $-\infty$ or in terms of outgoing pions at time equal to $+\infty$. Call these states $|I, I_3, J, \lambda, P\rangle_{\text{in}}$ or $|I, I_3, J, \lambda, P\rangle_{\text{out}}$, respectively. If we neglect the electromagnetic interactions, below the inelastic threshold these states can only differ by a phase. We thus define the pion-pion phase shifts $\delta_{J^I}(P^2)$ by

$$|I, I_3, J, \lambda, P\rangle_{\text{in}} = \exp[2i\delta_{J^I}(P^2)] |I, I_3, J, \lambda, P\rangle_{\text{out}}.$$

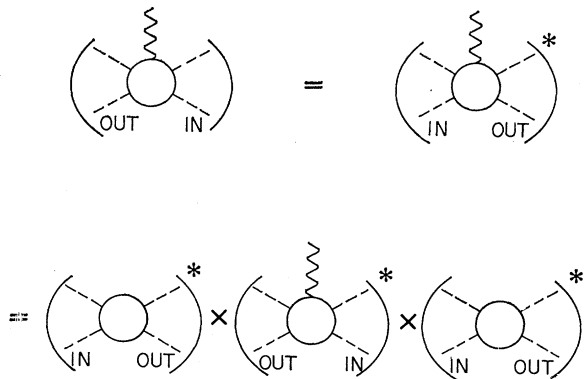
FIG. 8. Phase theorem for $\pi\pi \rightarrow \pi\pi\gamma$.

Isospin and Lorentz invariance tell us that $\delta_{I,J}(P^2)$ depends only on I, J , and P^2 .

Let T be the antiunitary time-reversal operator and $R_y(\pi)$ be a rotation of 180° about the y axis. Let $Y = TR_y(\pi)$. Consider 2π states with \mathbf{P} in the z direction. We can choose our phases²⁴ so that for these states

$$Y |I, I_3, J, \lambda, P\rangle_{\text{in (out)}} = |I, I_3, J, \lambda, P\rangle_{\text{out (in)}} \quad (\mathbf{P} \parallel \mathbf{e}_z).$$

Let $j_\mu(0)$ be the electromagnetic current at the point $x=0$. Form the following combinations of the $j_\mu(0)$:

$$\begin{aligned} j_+(0) &= j_1(0) + ij_2(0), \\ j_-(0) &= j_1(0) - ij_2(0), \\ j_0(0), & \quad j_3(0). \end{aligned}$$

These combinations all commute with Y .

Now we have the machinery necessary to derive phase theorems for pions. Before considering our reaction, let us demonstrate the technique on the reaction

$$\pi\pi \rightarrow \pi\pi\gamma.$$

Go to the center-of-mass frame for the initial pions with the final photon going in the $-z$ direction. Let λ'' be the photon helicity. The amplitude for this process is

$$T(s, t) = {}_{\text{out}} \langle I', I_3', J', \lambda', P' | j_{\lambda''}(0) | I, I_3, J, \lambda, P \rangle_{\text{in}}.$$

We define $s=P^2$, $t=P'^2$. Implicitly, T depends on λ, λ', J , and J' . Angular momentum conservation implies $\lambda' - \lambda'' = \lambda$. Consider s_0^* and t below the inelastic threshold

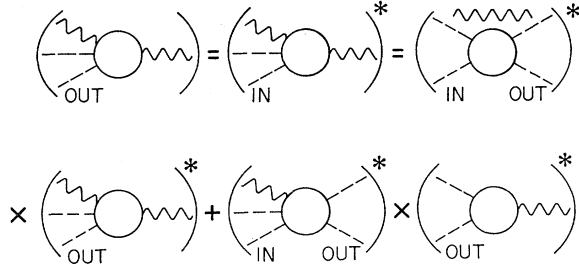
FIG. 9. Unitarity relation for " $\gamma \rightarrow \pi\pi\gamma$ " [Eq. (13)].

at $16m_\pi^2$. Inserting $j_{\lambda''}(0) = Y^{-1}j_{\lambda''}(0)Y$ into Eq. (6) implies

$$T(s, t) = (\text{in} \langle I', I_3', J', \lambda', P' | j_{\lambda''} | I, I_3, J, \lambda, P \rangle_{\text{out}})^* \\ = \exp\{2i[\delta_{J'}(s) + \delta_{J''}(t)]\} T^*(s, t).$$

This equation is shown with diagrams in Fig. 8. This gives our phase theorem²⁵:

$$\text{Im}\{\exp\{-i[\delta_{J'}(s) + \delta_{J''}(t)]\} T(s, t)\} = 0. \quad (10)$$

Phase theorems for the pion form factor or pion electroproduction on pions can be derived by replacing the state $|I, I_3, J, \lambda, P\rangle_{\text{in}}$ by the vacuum or one-pion state, respectively.

Now let us use this technique to investigate the virtual photon decay. Since $I_3=0$ for the two-pion states discussed here, we will not write I_3 explicitly. Working in the rest frame of the initial virtual photon with $s \leq (3m_\pi)^2$, we let λ' be the z component of this photon's angular momentum. Furthermore, let the final photon have helicity λ and four-momentum k with \mathbf{k} in the $-z$ direction. Then for the final photon state,

$$Y | \gamma(k, \lambda) \rangle = | \gamma(k, \lambda) \rangle.$$

With these conventions the matrix element for the process is

$$T(I, J, \lambda, \lambda', s, t) \\ = {}_{\text{out}} \langle I, J, \lambda + \lambda', Q; \gamma(k, \lambda) | j_{\lambda'}(0) | 0 \rangle. \quad (11)$$

²⁵ It is interesting that the low-energy theorem [F. E. Low, Phys. Rev. 110, 974 (1958)] for bremsstrahlung of a soft photon does not have the phase required by the theorem here. The source of this paradox rests in the masslessness of the photon. There are several ways to state its resolution. If the photon has a finite mass, however small, then our theorem is exact but there is no Low theorem. If the photon is massless, the low-energy theorem holds, but, strictly speaking, there does not exist an s -matrix element for scattering for a finite number of photons (the infrared divergence). From another point of view, one can say that perturbation theory is invalid for soft photons and our expression of unitarity is wrong. One way to preserve both the Low theorem and our theorem is to split the photon energy spectrum into "hard" and "soft" photons. Low's theorem applies for soft photons; our theorem, for hard photons. A particularly convenient formalism for expressing this fact incorporates coherent states. See T. W. B. Kibble, *ibid.* 175, 1624 (1968). Our theorem applies to Kibble's "core" amplitudes. Low's theorem is reflected in the coupling of the soft photons to the classical currents associated with the "in" and "out" states. This latter contribution is what Low refers to as the E_γ^{-1} contribution. The precise statement of the relationship of his $(E_\gamma)^0$ contribution and the soft-photon coupling eludes us.

Here $t = Q^2$, $s = (Q+k)^2$, and $\mathbf{k} = -\mathbf{Q}$. Using our operator $Y \equiv TR_\nu(\pi)$ gives

$$T = {}_{\text{out}} \langle I, J, \lambda + \lambda', Q; \gamma(k, \lambda) | Y^{-1} j_{\lambda'}(0) Y^{-1} Y | 0 \rangle \\ = [{}_{\text{in}} \langle I, J, \lambda + \lambda', Q; \gamma(k, \lambda) | j_{\lambda'}(0) | 0 \rangle]^*. \quad (12)$$

Now we try to relate the "in" state in Eq. (12) to the "out" state in Eq. (11) by inserting a sum over a complete set of "out" states:

$$| I, J, \lambda + \lambda', Q; \gamma(k, \lambda) \rangle_{\text{in}} \\ = \sum_n | n \rangle_{\text{out}} {}_{\text{out}} \langle n | I, J, \lambda + \lambda', Q; \gamma(k, \lambda) \rangle_{\text{in}}.$$

In the sum over $|n\rangle_{\text{out}}$ we find contributions to order e^2 in T from the state

$$| n \rangle = | I, J, \lambda + \lambda', Q; \gamma(k, \lambda) \rangle_{\text{out}},$$

as well as from the two-pion state

$$| n \rangle = | I=1, J=1, \lambda', P \rangle_{\text{out}},$$

where $P = Q + k$. Thus,

$$T = \exp[2i\delta_{J'}(t)] T^* - iT_{\pi\pi \rightarrow \pi\pi\gamma} \times T^*_{\gamma(P^2) \rightarrow \pi\pi}. \quad (13)$$

Here

$$-i(2\pi)^4 \delta^4(Q+k-P) \cdot T_{\pi\pi \rightarrow \pi\pi\gamma} \\ \equiv {}_{\text{out}} \langle I, I_3, J, \lambda + \lambda', Q; \gamma(k, \lambda) | I=1, J=1, \lambda', P \rangle_{\text{in}}, \\ T_{\gamma(P^2) \rightarrow \pi\pi} \equiv {}_{\text{out}} \langle I=1, J=1, \lambda', P | j_{\lambda'}(0) | 0 \rangle.$$

To get (13) we used Y in $T_{\pi\pi \rightarrow \pi\pi\gamma}$, and all the above equations are taken to lowest nontrivial order in e . [Equation (13) is shown diagrammatically in Fig. 9.] It is this second term on the right-hand side of Eq. (13) that does not permit us to derive an exact phase theorem. However, if somehow the contribution of an isoscalar initial photon could be isolated, we would have a phase theorem. This is because $T_{\gamma(s, I=0) \rightarrow \pi\pi} = 0$ to order e , so there is no additional term. We then have

$$\text{Im}\{\exp[-i\delta_{J'}(t)] T(\text{isoscalar } \gamma(P^2))\} = 0.$$

This theorem will break down at the threshold for isoscalar continuum states; this occurs at $s = (3m_\pi)^2$. For isovector photons, Eq. (13) holds for $s \leq (4m_\pi)^2$ as does Eq. (10). This difference is a consequence of G -parity conservation.

If we had a hadron that only decayed into $2\pi\gamma$, then we could derive a phase theorem as discussed above. If this hadron were unstable, we might still expect an approximate phase relation if the width were small compared with its mass. Furthermore, if there were such a relation, it should be independent of how the particle was created. We now derive heuristically an approximate relation for the reaction of interest $e^-e^+ \rightarrow \pi^- \pi^+ \gamma$.

Virtual photons couple to the vector mesons ρ , ω , and ϕ . Let m_V be the mass of one of these mesons. Set s near m_V^2 and $t \leq 16m_\pi^2$. Expanding (13) to include

other hadronic states gives

$$2i \operatorname{Im}\{\exp[-i\delta_J(t)]T\} \\ = \sum_{n=\text{hadron}} \operatorname{out}\langle I, J, \lambda+\lambda', Q; \gamma(k, \lambda) | n \rangle_{\text{in}} \\ \times [\operatorname{out}\langle n | j_{\lambda'}(0) | 0 \rangle]^* \exp[-i\delta_J(t)]. \quad (14)$$

Note that both sides of this equation are purely imaginary. If there were a stable vector particle contributing to the sum over n , the right-hand side would have a contribution proportional to $\delta(m_V^2-s)$. This indicates that for s near m_V^2 for an unstable vector particle Eq. (14) is approximately

$$2i \operatorname{Im}\{\exp[-i\delta_J(t)]T\} \\ \approx -2i\{m_V\Gamma_V/[s-m_V^2+m_V^2\Gamma_V^2]\} \times R_{I,J}(t), \quad (15)$$

where $R_{I,J}(t)$ is some real function.

Assuming analyticity in the upper half s plane, Eq. (15) implies that near the resonance,

$$T(s, t) \approx \exp[i\delta_J(t)]R_{I,J}(t) \{1/[s-m_V^2+im_V\Gamma_V]\}. \quad (16)$$

This is the approximate phase relation mentioned above. If the vector meson is a simple pole on the second Riemann sheet, a continued form of this relation should become arbitrarily accurate as this pole is approached. We remind the reader that T implicitly depends on I, J, λ , and λ' . In the case of the ϕ meson, the width Γ_V is only 4 MeV and this relation should be quite good. The restriction $t \leq 16m_\pi^2$ can in practice be dropped as long as four-pion states are unimportant, which we expect to be true up to 900 or 1000 MeV.

Let us close this section with the suggestion of using Eq. (16) to parametrize the data on $e^+e^- \rightarrow \pi^+\pi^-\pi^+\pi^- + \gamma$. Assuming that the reaction is dominated by $I=J=0$ in the two-pion final state, a simple approximation for an ϵ resonance would be²⁶

$$\exp[i\delta_0^0(t)]R_{00}(t) \approx S(t)[1/(t-m_\epsilon^2+im_\epsilon\Gamma_\epsilon)], \quad (17)$$

where $S(t)$ is a polynomial and m_ϵ and Γ_ϵ are parameters, all chosen to fit the data. Equation (17) does not have the right analytic behavior near the threshold at $t=4m_\pi^2$. This might be a problem if Γ_ϵ was very large. An effective-range approximation does behave correctly at threshold; thus, a more sophisticated procedure would be to use

$$\exp[i\delta_0^0(t)]R_{00}(t) \approx S'(t) \exp\left[\frac{1}{\pi} \int_{4m_\pi^2}^{\infty} \frac{\delta_0^0(t') dt'}{t'-t-i\epsilon} \left(\frac{t}{t'}\right)\right], \quad (18)$$

where $S'(t)$ is a low-order polynomial and an effective-range approximation is made for $\delta_0^0(t)$.²⁷ We anticipate

²⁶ We ignore the question of kinematical singularities here. The statements in this paragraph must be applied to kinematical-singularity-free amplitudes.

²⁷ This approximation is $[(t-4m_\pi^2)^{1/2}/(m_\epsilon^2-4m_\pi^2)^{1/2}] \cot\delta_0^0 = (m_\epsilon^2-t)/m_\epsilon\Gamma_\epsilon$. This equation relates Γ_ϵ to the slope of the phase shift of $\frac{1}{2}\pi$. Equation (16) relates Γ_ϵ to the width of a Breit-Wigner resonance formula. For a broad resonance, these two definitions can be in substantial disagreement: M. B. Einhorn, Phys. Rev. **185**, 1960 (1969).

that such an approach to the parametrization of H_3 will be useful phenomenologically.

CONCLUSIONS

The recent observations⁸ of $\pi^-p \rightarrow \pi^0\pi^0n$ provide unmistakable evidence for the existence of the ϵ .²⁸ Observation of the reaction discussed in this paper may still be interesting for two reasons: (1) This reaction may be the only way to observe clearly the charged pion decay mode of the ϵ . (2) The dynamical and, especially, the kinematical analysis of this reaction appears to be simpler than for $\pi N \rightarrow 2\pi N$. Furthermore, as discussed in Sec. III, one can hope to obtain reliable values for the ϵ mass and width.

The same experiment described here at higher energy and higher dipion invariant mass can be used to examine other isosinglet mesons, such as the $\eta_0(1070)$, $f(1260)$, and $f'(1515)$. It goes without saying that the analysis in this paper applies equally well to $e^-e^+ \rightarrow K\bar{K}\gamma$, except that $K\bar{K}$ in a C -even (J -even) state can have either $I=0$ or $I=1$. Similarly, $e^-e^+ \rightarrow 3\pi\gamma$ can be used to study three pions in a C -even state. In addition to the mesons mentioned above, one can use these reactions to study the $A_1(1070)$, $\pi_N(1016)$, $A_2^H(1320)$, and perhaps the $A_2^L(1270)$, to name a few. Turning to particles with spin, we recall that in baryon-antibaryon production $e^-e^+ \rightarrow B\bar{B}$ in the one-photon annihilation approximation, the selection rules $J=1$, C odd, along with parity odd, restrict the final state to be 3S_1 or 3D_1 . The reaction $e^-e^+ \rightarrow B\bar{B}\gamma$ opens up the C -even channel, which low angular momenta include the 1S and 1D states as well as the 3P_0 , 3P_1 , 3P_2 , and 3F_2 states.

As long as we are considering higher-order effects, we should recall that there are contributions of order α^3 to $e^-e^+ \rightarrow \pi^-\pi^+$ from two-photon annihilation.²⁹ This will also lead to a C -even final state, although it will require a very accurate (1%) experiment to isolate this interference effect. On the other hand, the counting rate obtainable should make possible this accuracy, so an s -wave enhancement will be seen here as well.

One could probably also utilize $e^-e^+ \rightarrow \pi^-\pi^+\gamma$ when the two pions have little kinetic energy, $t \approx 4\mu^2$, to investigate the soft-pion theorems of current algebra. In the other extreme, for a very soft photon, $t \approx s$, the amplitude is given by Low's theorem. Can these two limits be somehow expressed as subtractions in a dis-

²⁸ These experiments had not been reported when this work was begun. The use of this reaction to determine the existence of the ϵ was one reason we brought in so many kinematical details.

²⁹ This was called to our attention by S. J. Brodsky. See R. Gatto in Proceedings of the International Symposium on Electron and Photon Interactions at High Energies, Hamburg, 1965, p. 122 (unpublished). $d\sigma_{-+} - d\sigma_{+-}$ receives its lowest contribution in order α^3 from interference of the one-photon annihilation with the two-photon contribution. Incidentally, in the symmetrical experiments, $d\sigma_{-+} + d\sigma_{+-}$, as Gatto points out, there is no two-photon contribution to this order. The selection rules $P=-1$, $C=-1$, $J=1$ are not violated in symmetrical experiments until order α^4 ; however, even in order α^3 isospin is not well defined, so that one cannot assert that $I=1$ until order α^4 .

persion relation analysis of the amplitude?³⁰ What other dynamical effects can be studied if one is given the differential cross section?

In conclusion, we anticipate that the general method described in L for the analysis of C -even states from colliding beams will expand considerably the usefulness of high-luminosity storage rings. We have illustrated the method with a detailed discussion of $e^-e^+ \rightarrow \pi^-\pi^+\gamma$, and, in particular, related this analysis to the question of the existence of the ϵ meson.

ACKNOWLEDGMENTS

It is our pleasure to thank B. Richter for discussions of the experimental possibilities. We have enjoyed several discussions with J. Ballam, S. J. Brodsky, and S. D. Drell. The Appendix probably could not have been completed with some hope of accuracy without the help of the REDUCE program, the SLAC IBM 360, and the patient tutelage of S. J. Brodsky. Finally, we would like to pay special tribute to the SLAC library staff for their assistance with preprints and especially to Mrs. Louise Addis for a literature search via SPIRES.

APPENDIX

In this appendix, we display the unfortunately complicated expressions for the cross sections discussed in Sec. II. There is some arbitrariness as to the choice of variables in which to express everything. It has been our experience that the simplest choice is the two energies, s and t , and three angles, θ_γ , $\theta_{\pi\gamma}$, and ϕ , defined in the text.

The dependence of the cross section on the angles θ and ϕ is explicit; the several form factors depend only on s , t , and $\theta_{\pi\gamma}$. In terms of these variables

$$w = -\beta_\pi [(s+t) \cos\theta_{\pi\gamma} \cos\theta_\gamma + (st)^{1/2} \sin\theta_{\pi\gamma} \sin\theta_\gamma \cos\phi].$$

³⁰ This question was raised by S. D. Drell.

The contribution from photon emission from the leptons is then [cf. Eq. (9)]

$$\begin{aligned} \langle |B|^2 \rangle = & [2e^2 |F_\pi(t)|^2 \beta_\pi^2 / t (s-t)^2 \sin^2\theta_\gamma] \\ & \times \{ (s+t)^2 (1 + \cos^2\theta_\gamma) \\ & - [2(st)^{1/2} \sin\theta_\gamma \sin\theta_{\pi\gamma} \cos\phi + (s+t) \cos\theta_\gamma \cos\theta_{\pi\gamma}]^2 \}. \end{aligned} \quad (A1)$$

The contribution to emission from the final state is

$$\begin{aligned} \langle |A|^2 \rangle = & \frac{1}{2} |H_1|^2 \beta_\pi^2 t \sin^2\theta_\gamma \sin^2\theta_{\pi\gamma} \\ & + \frac{1}{2} |H_2|^2 \frac{1}{2} \beta_\pi^4 t \sin^2\theta_{\pi\gamma} \{ \cos^2\theta_{\pi\gamma} + (t/s) \sin^2\theta_{\pi\gamma} \\ & - [\cos\theta_\gamma \cos\theta_{\pi\gamma} + (t/s)^{1/2} \sin\theta_\gamma \sin\theta_{\pi\gamma} \cos\phi]^2 \} \\ & + (|H_3|^2 / 2s) (1 + \cos^2\theta_\gamma) \\ & + \text{Re}(H_1 H_2^*) \beta_\pi^3 t \sin\theta_\gamma \sin^2\theta_{\pi\gamma} \\ & \times [(t/s)^{1/2} \sin\theta_{\pi\gamma} \cos\theta_\gamma \cos\phi - \sin\theta_\gamma \cos\theta_{\pi\gamma}] \\ & + \text{Re}(H_1 H_3^*) \beta_\pi (t/s)^{1/2} \sin\theta_\gamma \cos\theta_\gamma \sin\theta_{\pi\gamma} \cos\phi \\ & + \text{Re}(H_2 H_3^*) \beta_\pi^2 (t/s)^{1/2} \sin\theta_{\pi\gamma} [\sin\theta_\gamma \cos\theta_\gamma \cos\theta_{\pi\gamma} \cos\phi \\ & + (t/s)^{1/2} \sin\theta_{\pi\gamma} (1 - \sin^2\theta_\gamma \cos^2\phi)]. \end{aligned}$$

The interference term is

$$\begin{aligned} \langle 2\text{Re}(A^*B) \rangle = & [\text{Re}F_\pi^* / 64st(s-t) \sin^2\theta_\gamma] \\ & \times \{ H_3 \beta_\pi \sin\theta_\gamma (st)^{1/2} [2(st)^{1/2} \sin\theta_\gamma \cos\theta_\gamma \cos\theta_{\pi\gamma} \\ & - (s-t + (s+t) \cos^2\theta_\gamma) \sin\theta_{\pi\gamma} \cos\phi] \\ & + H_2 \beta_\pi^3 st [(s-t) \cos^3\theta_\gamma \sin^2\theta_{\pi\gamma} \cos\theta_{\pi\gamma} \\ & - (t/s)^{1/2} \sin\theta_\gamma \sin\theta_{\pi\gamma} \cos\phi (t \cos^2\theta_\gamma \sin^2\theta_{\pi\gamma} + s(2 \sin^2\theta_\gamma \\ & + \cos^2\theta_\gamma \sin^2\theta_{\pi\gamma})) + 2(s+t) \sin^2\theta_\gamma \cos\theta_\gamma \sin^2\theta_{\pi\gamma} \cos\theta_{\pi\gamma} \cos^2\phi \\ & + 2(st)^{1/2} \sin^3\theta_\gamma \sin^3\theta_{\pi\gamma} \cos^3\phi] \\ & + H_1 \beta_\pi^2 st \sin^2\theta_\gamma \sin\theta_{\pi\gamma} [(s-t) \cos\theta_\gamma \sin\theta_{\pi\gamma} \\ & + 2(st)^{1/2} \sin\theta_\gamma \cos\theta_{\pi\gamma} \cos\phi - 2s \cos\theta_\gamma \sin\theta_{\pi\gamma} \cos^2\phi] \}. \end{aligned}$$